



BISON PRECAST

a Forterra brand

TYPE 3 DECK

Omnia Bridge Deck - For a 250mm deep overall slab

Note: Do not scale from this drawing. If in doubt, please ask for confirmation of any dimension.

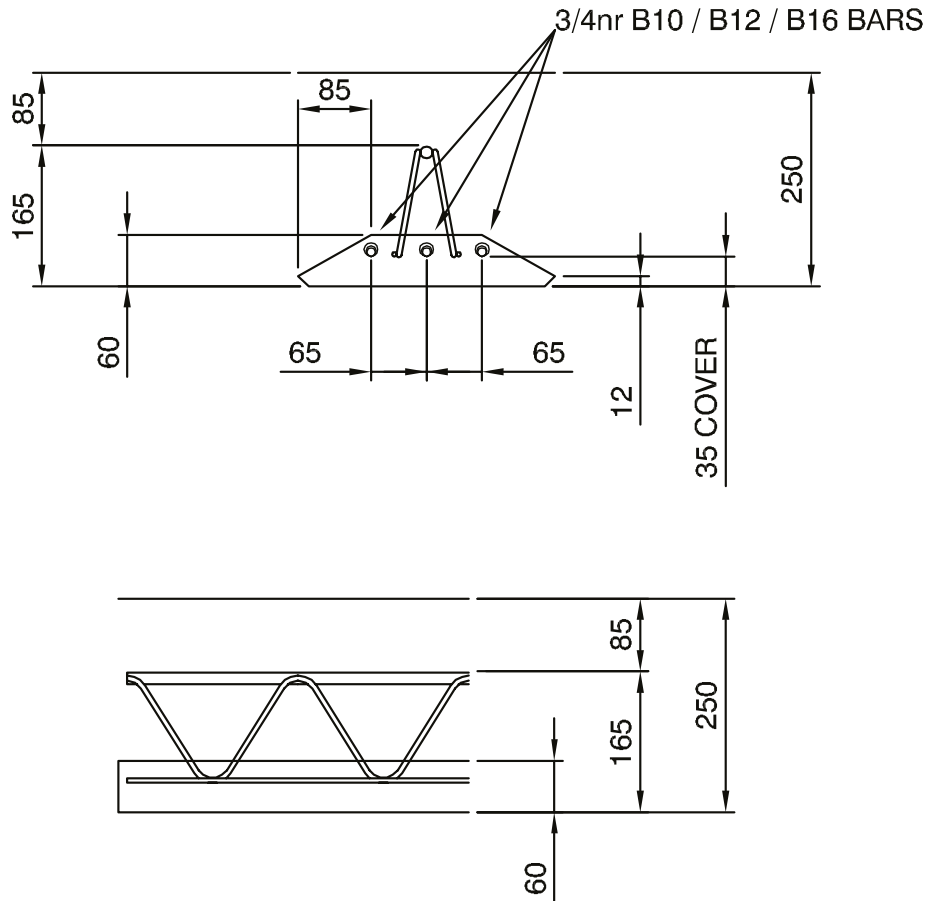

Omnia plank depth:	60mm
Overall depth including lattice:	165mm
Cover to reinforcement:	35mm
Lattice depth:	130mm
Allowance for in situ reinforcement and cover:	85mm