



**BISON PRECAST**

a Forterra brand

# TYPE 1 DECK

Omnia Bridge Deck - For a 200mm deep overall slab

Note: Do not scale from this drawing. If in doubt, please ask for confirmation of any dimension.

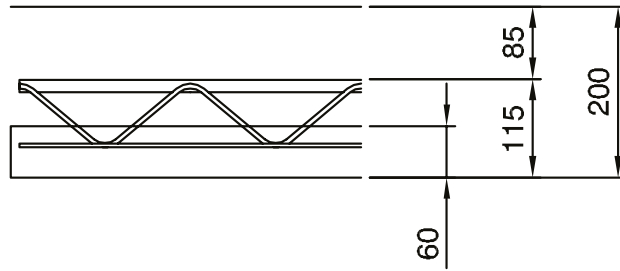
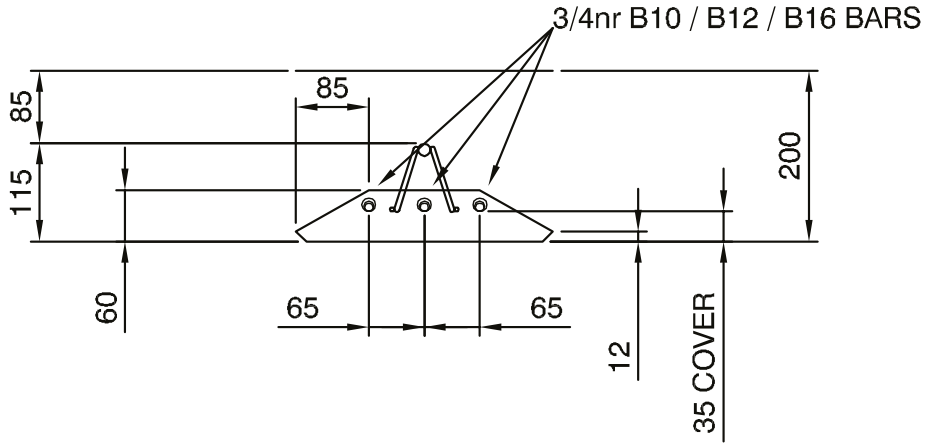

Omnia plank depth:	60mm
Overall depth including lattice:	115mm
Cover to reinforcement:	35mm
Lattice depth:	80mm
Allowance for in situ reinforcement and cover:	85mm

OUR PEOPLE. OUR PASSION. OUR PRODUCTS

The components you need for a more successful project.

Bison Precast - Tetron Point - William Nadin Way - Swadlincote - Derbyshire - DE11 0BB

01283 817 500 concrete@bison.co.uk bison.co.uk