

# Type 4 deck

## Omnia Bridge Deck

For a 275mm deep overall slab

**Precast Products**

Note: Do not scale from this drawing. If in doubt, please ask for confirmation of any dimension.

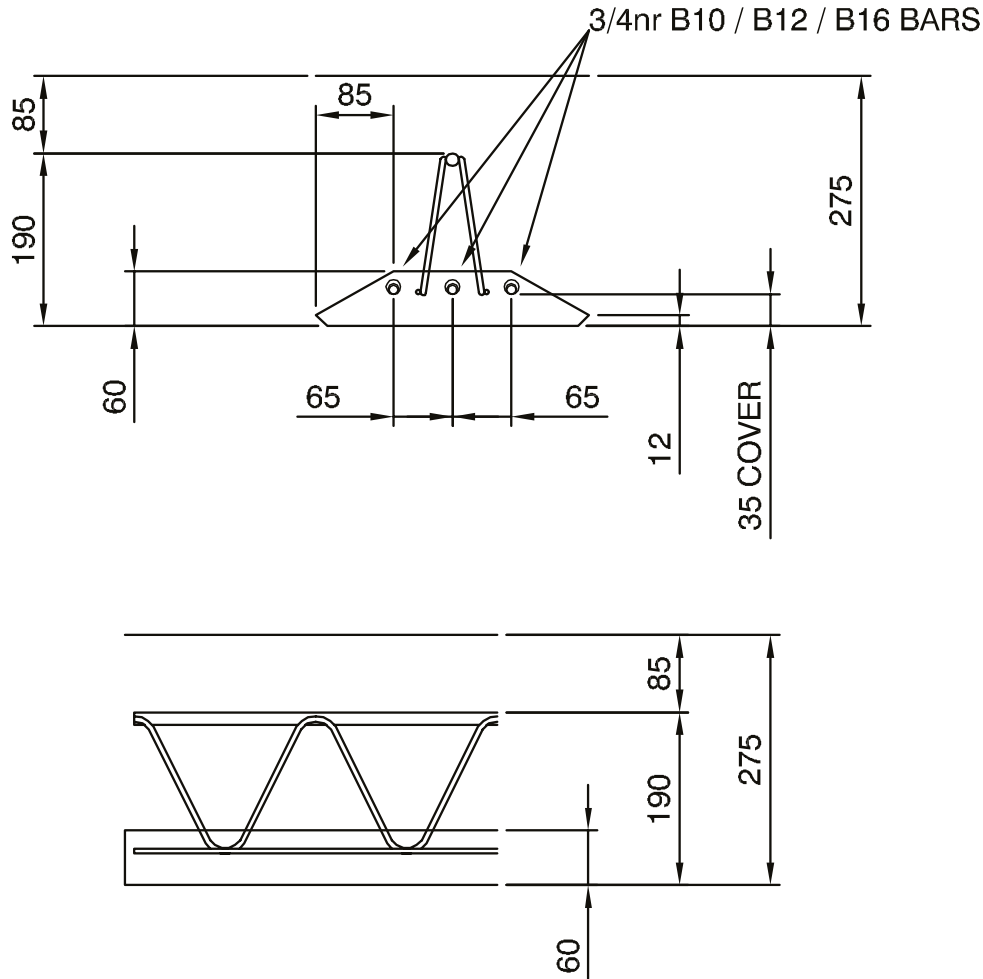

Omnia plank depth:	60mm
Overall depth including lattice:	190mm
Cover to reinforcement:	35mm
Lattice depth:	155mm
Allowance for in situ reinforcement and cover:	85mm

For further information please call  
or email our dedicated sales team.

→ **01773 600 211**

[bridgedeck@forterra.co.uk](mailto:bridgedeck@forterra.co.uk)



**FORTERRA™**

All content copyright © 2015 Forterra