

Type 1 deck

Omnia Bridge Deck

For a 200mm deep overall slab

Precast Products

Note: Do not scale from this drawing. If in doubt, please ask for confirmation of any dimension.

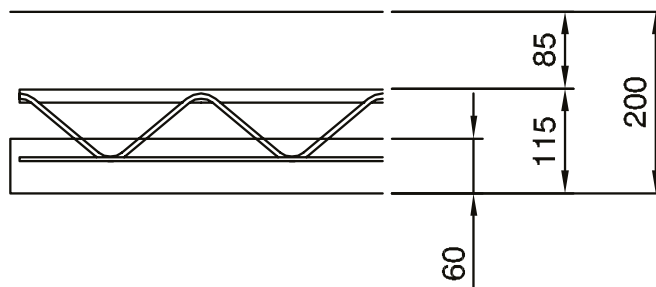
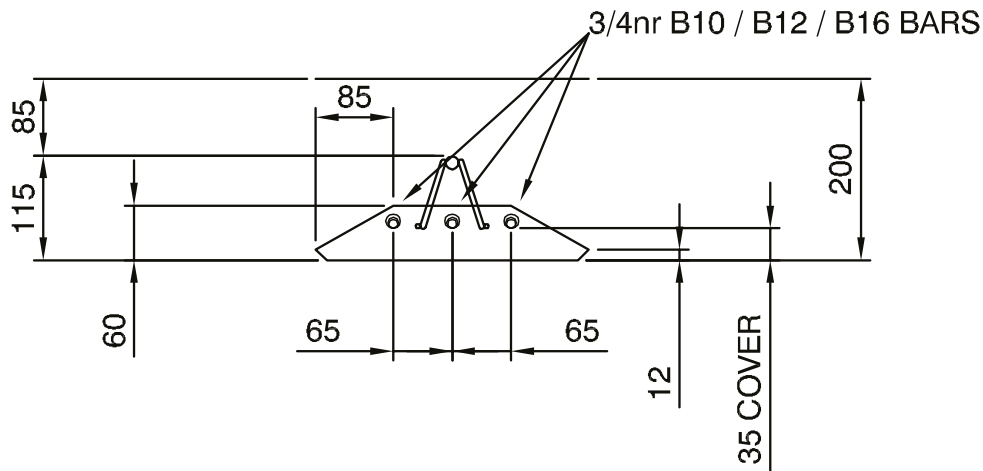

Omnia plank depth:	60mm
Overall depth including lattice:	115mm
Cover to reinforcement:	35mm
Lattice depth:	80mm
Allowance for in situ reinforcement and cover:	85mm

For further information please call
or email our dedicated sales team.

→ **01773 600 211**

bridgedeck@forterra.co.uk



FORTERRA™

All content copyright © 2015 Forterra